

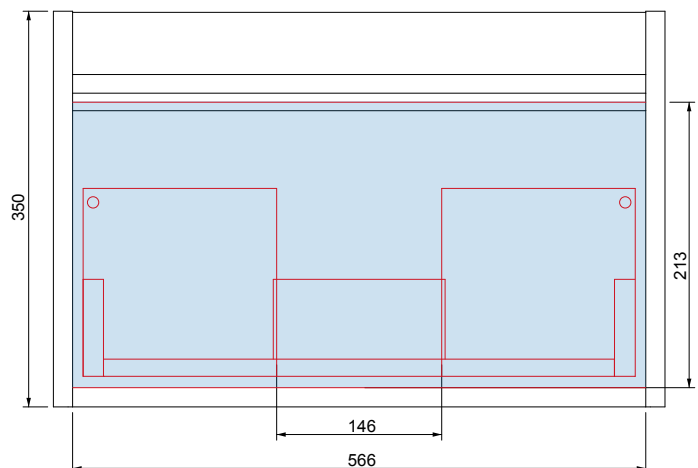

PRODUCT	LORETO 600 VANITY UNIT (22KG)
UNIT SIZE	600w x 450d x 350h
BASIN OPT1	IDRO CAST (12KG)
BASIN SIZE	610w x 460d x 15h
BASIN OPT2	AQUARA CERAMIC - 9136 (28KG)
BASIN SIZE	610w x 460d x 35h

FITTING ADVICE

- The shaded areas indicate the clear voids for the running of services.
- This unit is heavy. A secure wall fixing is required.
- To aid installation, it is recommended to remove the drawers to give full access and to avoid damage.
- Recommended height from floor to top of vanity unit carcass is 810mm.
- All wall to carcass and wall to basin joints should be sealed with silicone.
- All dimensions are in mm.

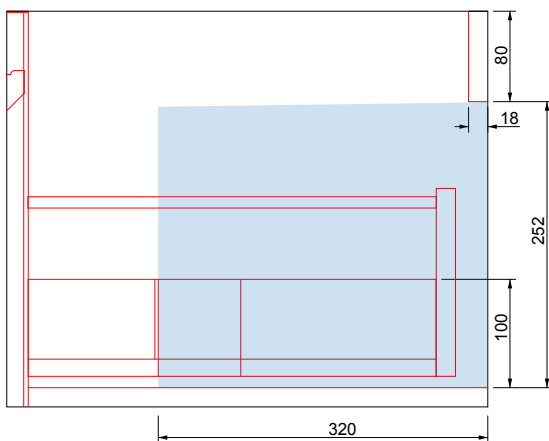

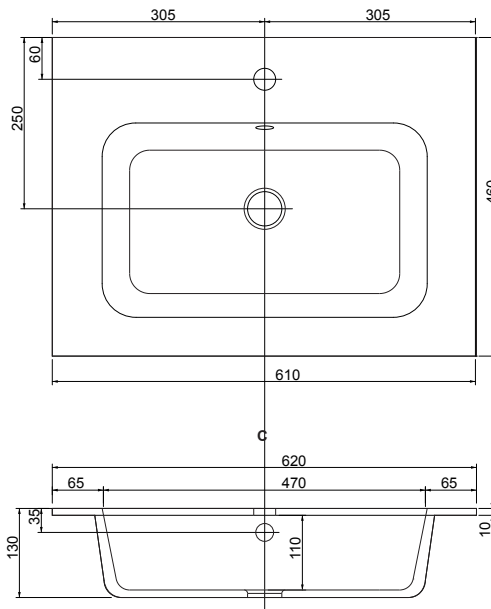

CAST MARBLE BASINS

The core ingredient of our Cast Marble basins is Dolomite Marble which is formed through volcanic action. The rock is milled and purified before being mixed with polymer resin formed into the required shape and then coated with a resin and quartz mixed gel coat to save its pigment and smooth finish.

The result is an extremely durable and easy to maintain product coupled with the benefit of constant sizing and smooth finishing that cannot be matched by traditional ceramics. Scratches are also repairable making this a more forgiving option. Cast basins have a sharp and ultra modern structured appeal to them.



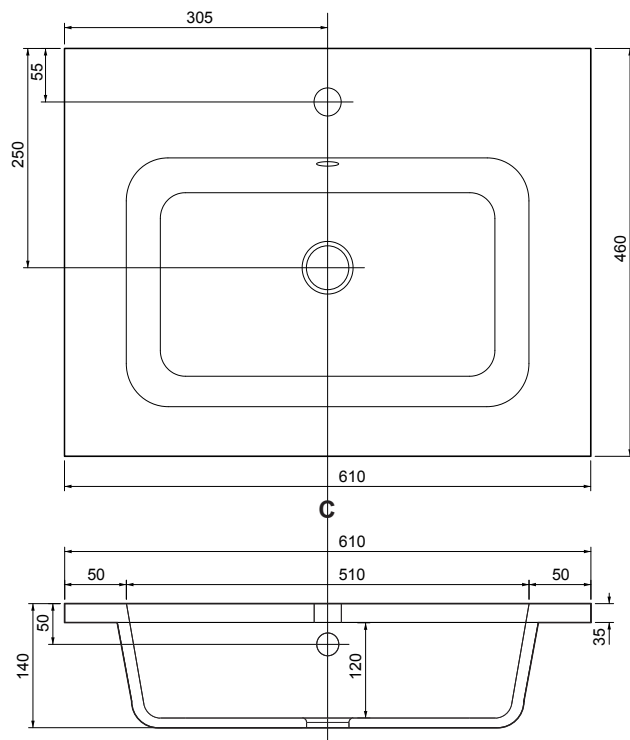
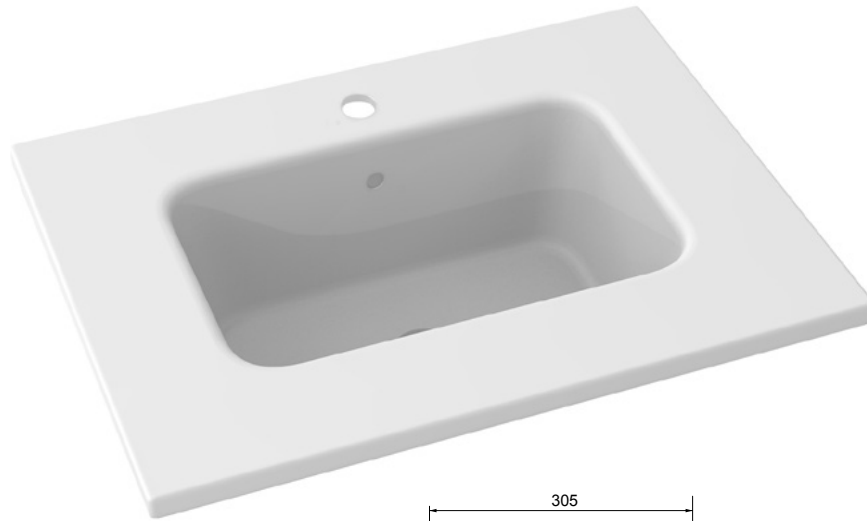

CERAMIC BASINS

Ceramic Basins are made out of liquefied fireclay which is poured into a mould and allowed to set before being hand finished. A ground glass glaze would typically be sprayed over the basin before the final firing.

This long-lasting, durable material suits a simple and minimalistic bathroom suite as well as a traditional Victorian look. Stains are easily removed and ceramic is generally easy to clean to maintain a shiny appearance. The slight ripples occasionally seen along its surface are often mistaken for flaws these are actually part of the ceramic basins characteristics.



To aid installation, it is recommended to remove the drawers to give full access and to avoid damage.

1. Fit the hanging plate to the wall using suitable fixings for the substrate.
2. Hang vanity carcass on the hanging plate and level.
3. Fix through the upper bar locations as suggested below.
4. Silicone around the top of the unit and place basin.
5. Silicone around the rear of the unit at wall abutment.
6. Re-fit drawer(s)

