

# venturi 8

## Slider

AQUA  
DART

### INSTALLATION INSTRUCTIONS

[www.aquadart.co.uk](http://www.aquadart.co.uk)

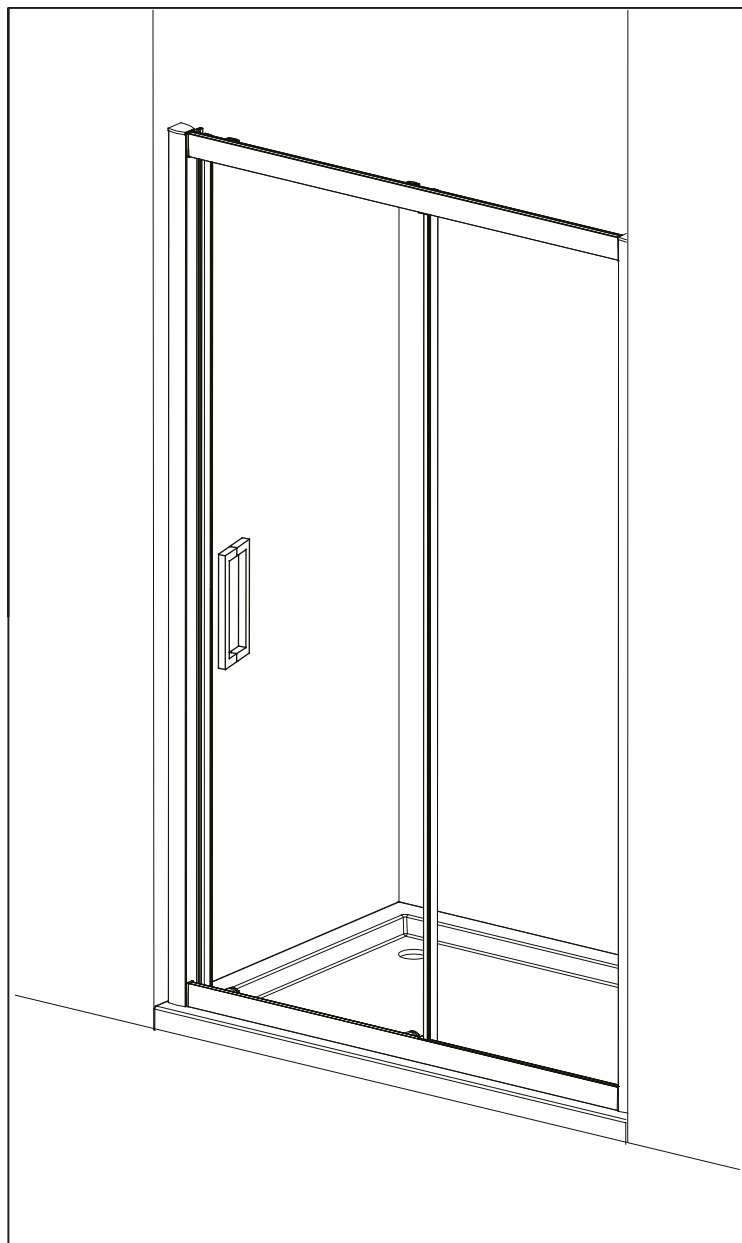

#### Tools Required



**Drill**



**6mm Masonry Drill**  
**2.75mm HSS Drill**

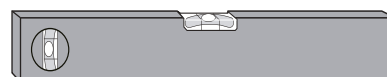

**Spirit level**



**Sealant Gun**

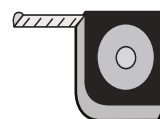

**Tape Measure**



**Pencil**



**PH2 TYPE**  
**Screwdriver**

Please note hand tools **NOT** supplied.

#### IMPORTANT

This product should be installed by a suitably qualified and proficient person. The fitting instructions should be followed carefully to ensure a proper and safe installation. Failure to follow these instructions could result in future injury.

These instructions and list of parts assume that installation is done against solid/tiled walls.

Please check this product for damage prior to starting the installation. No claims can be made after the product has been fitted.

PLEASE NOTE :The minimum and maximum adjustment sizes noted on the product brochures are based on perfectly plumb walls and trays.

**USE SAFETY EYE-WEAR WHEN DRILLING**

## COMPONENTS AND BOX CONTENTS

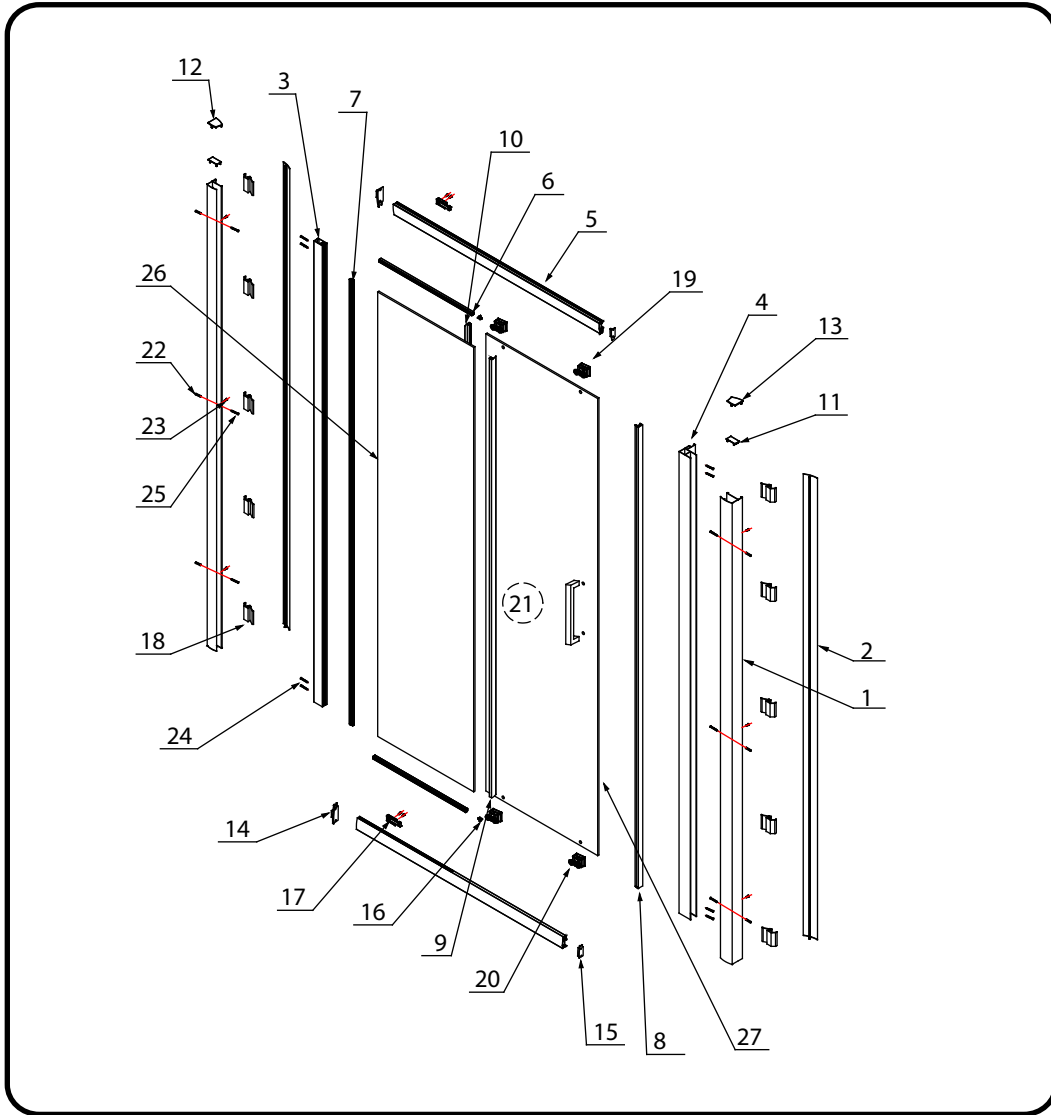

### Box Contents

SN	Description	Qty	SN	Description	Qty
1	Wall Profile	2	15	Horizontal Profile Cap-R	1SET
2	Cover Profile	2	16	Glass Clip	2
3	Upright Profile	1	17	Soft Closing Buffer	1SET
4	Closing Profile	1	18	Profile Clip	10
5	Horizontal Profile	2	19	Top Roller	2
6	U Shape Seal	2	20	Bottom Roller	2
7	Seal	1	21	Handle	1
8	Door Seal	1	22	Wall Plug	8
9	Upright Seal-6-14.5 mm	1	23	Screw ST3.5x10	8
10	Upright Seal-8-16.5 mm	1	24	Screw ST4x30	8
11	Upright Profile Cap	2	25	Screw ST4x30	8
12	Wall Profile Cap-L	1	26	Side Glass Panel	1
13	Wall Profile Cap-R	1	27	Moving Glass Panel	1
14	Horizontal Profile Cap-L	1 SET			

# FIXING KIT COMPONENTS, SITE CONDITIONS

## FIXING KIT

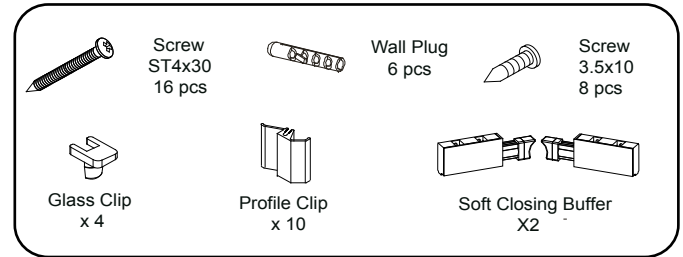
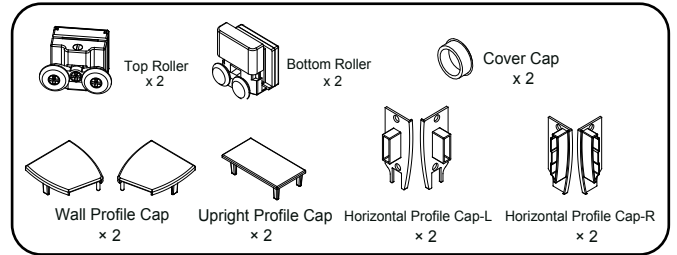
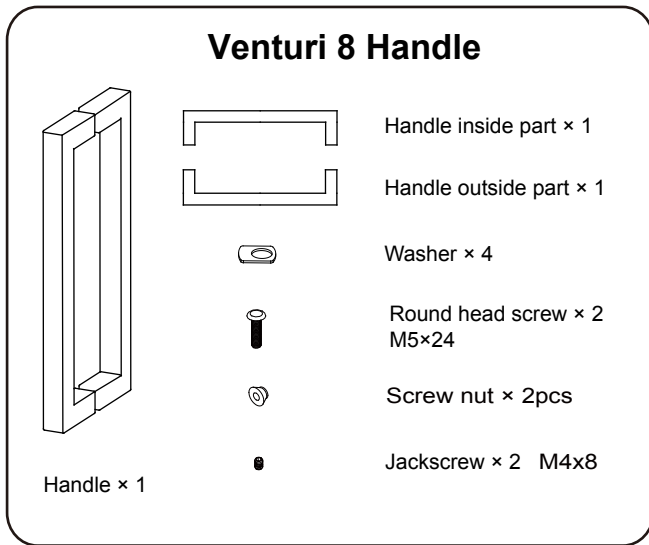

## IMPORTANT - Missing Components

Please check this product for missing components prior to installation.

For spare parts visit [www.aquadart.co.uk](http://www.aquadart.co.uk)

## IMPORTANT - Installation site

1. Ensure the top surface of the shower tray on which the enclosure will be installed is level in every direction.
2. The tiles or other wall finishing should be effectively sealed at tray edges.
3. Tiles should extend at least to the corner of the tray and a minimum of 1.9 meters from the top of the tray.

## PROCEDURE

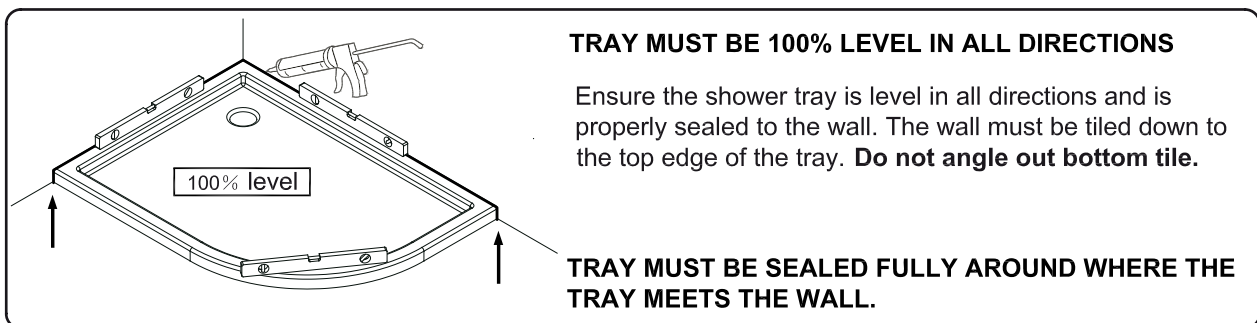

# Slider

## INSTALLATION INSTRUCTIONS

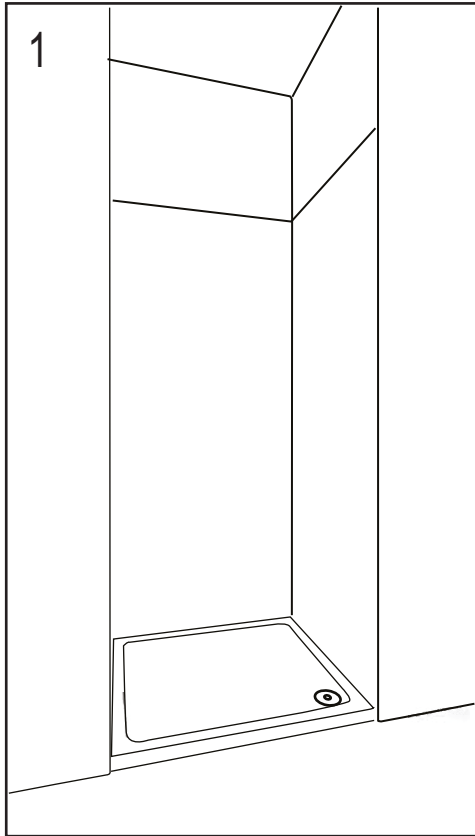

1 - Install the shower tray following the tray installation guide.

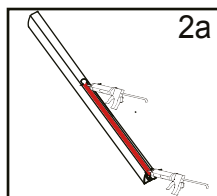
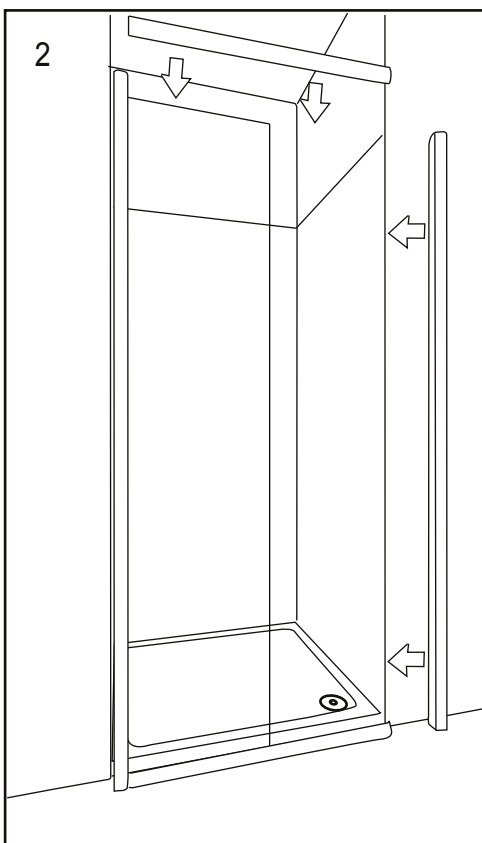

2a - Drop the silicone into the groove of the rail profile along with the pre-fitted seal, then push 1x horizontal rail onto the bottom of the fixed panel.

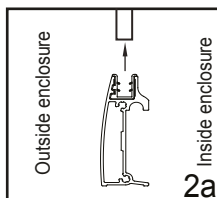

2b - Insert the horizontal profile cap (left and right) then fix the pieces together using 2 x ST4x30 fixing screws through the metal profile of the fixed panels and into the end of the horizontal rail. (Note: Put a little bit of silicone in the corner of the profile cap and the horizontal profile as the diagram shown). Once this is done repeat for the top horizontal rail.

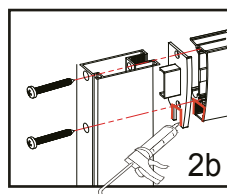

2c - Then fix the closing profile to the top and bottom rail in the same way. Ensure that the closing profile faces the correct direction as illustrated.

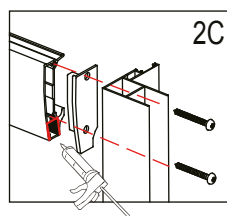

# Slider

## INSTALLATION INSTRUCTIONS

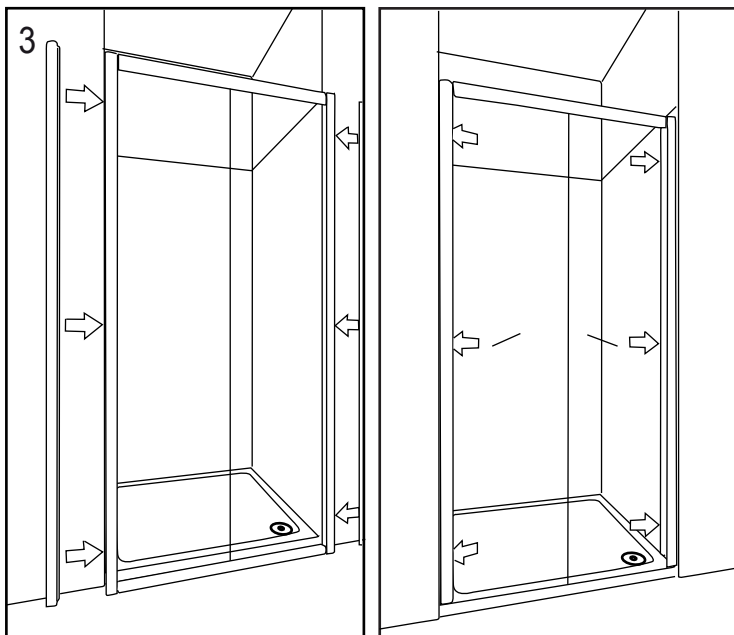

3 - Push the wall channels onto the edges of the assembly as illustrated and then position the assembly onto the shower tray as shown (roughly 10mm from the front of the tray).

Level the wall channels using a spirit level and mark the 4 pre-drilled screw points through each of the wall channels onto the wall.

NOTE: you may find it easier to mark and drill the wall if you apply masking tape to it first.

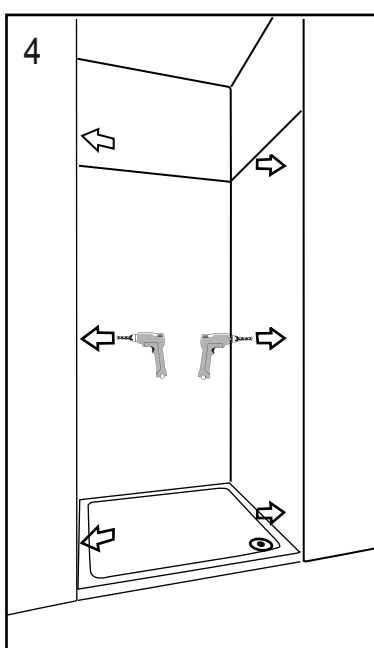
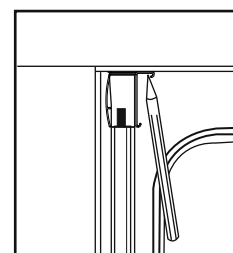
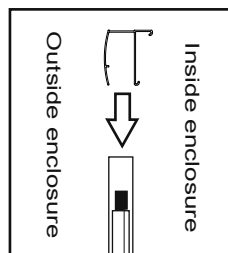

4 - Remove the assembly and drill the marked points using a 6mm masonry drill bit, once this is done insert 8 x wall plugs into the holes.

# Slider

## INSTALLATION INSTRUCTIONS

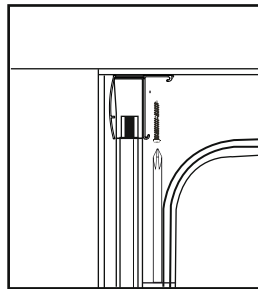
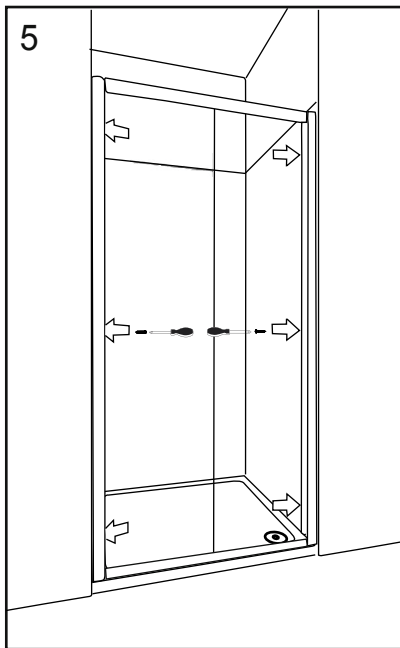

5 - Reposition the assembly and fix the wall channels to the wall using 8 x ST4x30 long screws (4 per channel).

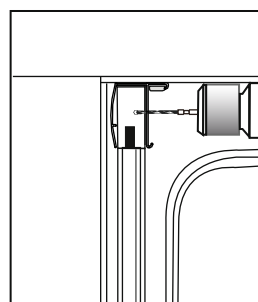
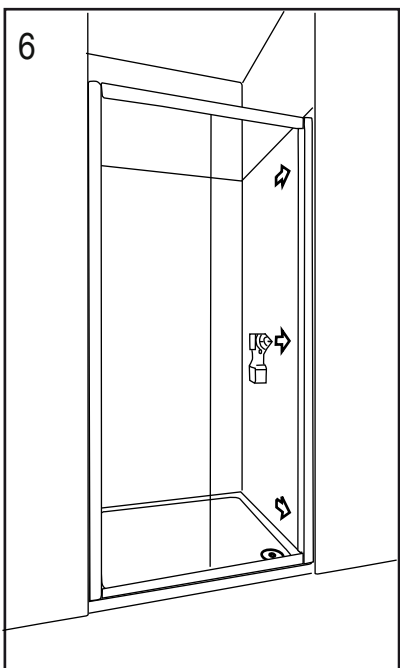

6 - Whilst using the available play to ensure that the assembly is central between the wall channels and held against the shower tray at the bottom fix the assembly to the wall channels by drilling through the pre drilled holes in the wall channels into the profiles using a 2.75mm metal drill bit . Then secure using 8xST3.5x10 short Screws (4 per wall channel).

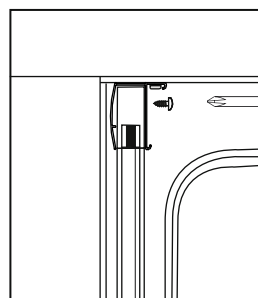

# Slider

## INSTALLATION INSTRUCTIONS

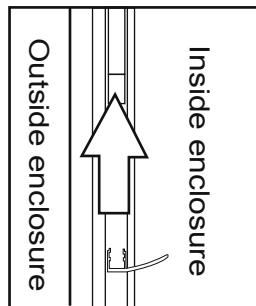
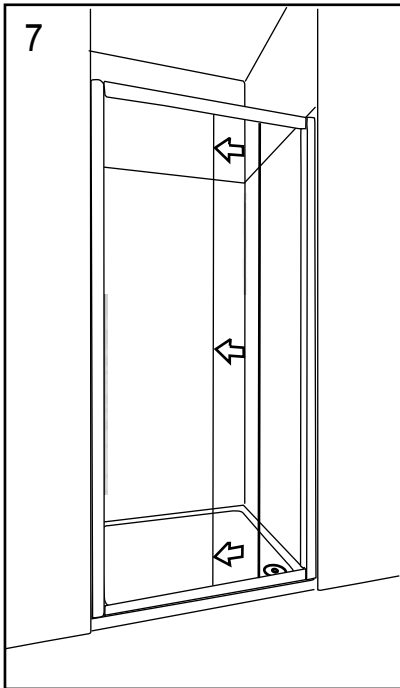

7 - Push the shorter of the 2 water seals onto the exposed glass edges of the fixed panels, the flap should face into the shower as illustrated.

NOTE: If both water seals are the same size then some trimming may be required.

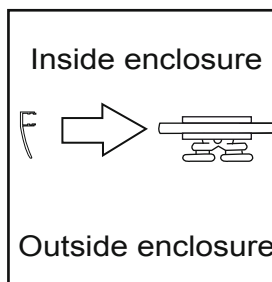
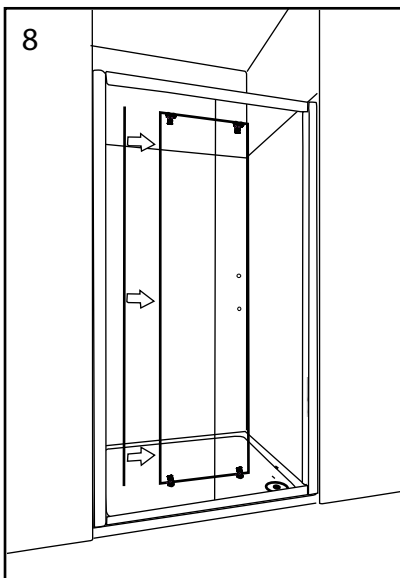

8 - Fit the rollers to the door. Ensure that the wheels of the rollers are facing away from the enclosure. Ensure the top rollers are fixed to the top of the door and the bottom rollers are fixed to the bottom of the door.

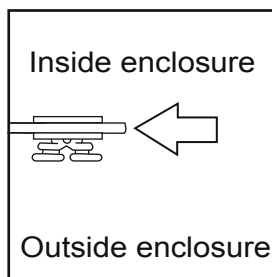

Attach the handle making sure that the rubber washers that come with the handle are placed between the handles and the glass.

The next step is to push the longer water seal onto the edge of the door furthest from the handle (the flap should face out of the enclosure).

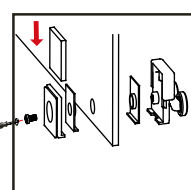
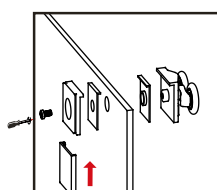
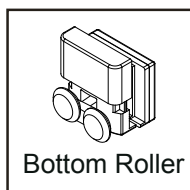
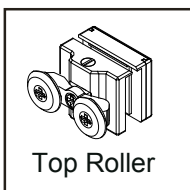

# Slider

## INSTALLATION INSTRUCTIONS

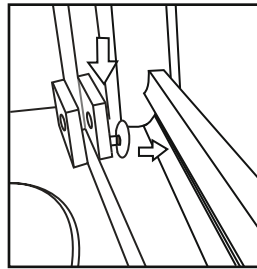
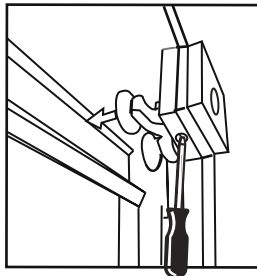
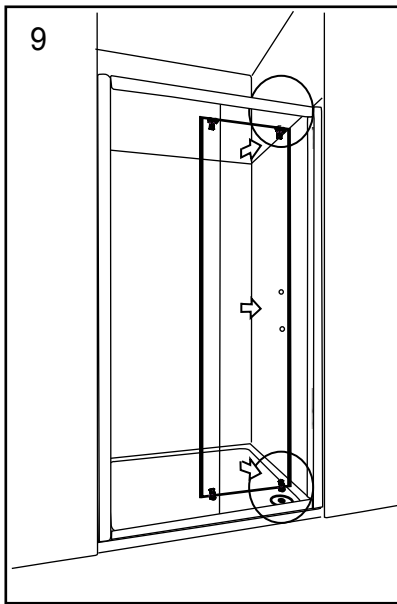

9 - Once the door is ready it needs to be hung in the enclosure , start by lifting the door up and guiding the top support wheels into the top horizontal profile , then using the quick release mechanism on the bottom wheels guide them into the bottom horizontal profile as shown.

If the wheels do not fit into the profile , the door can be lowered by adjusting the top runners . The bottom runners are also adjustable.

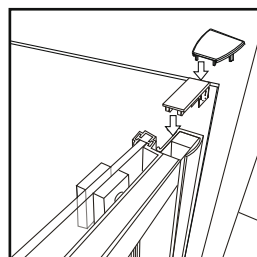
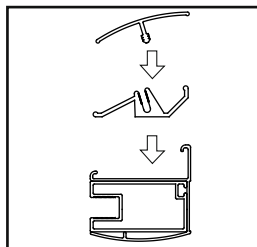
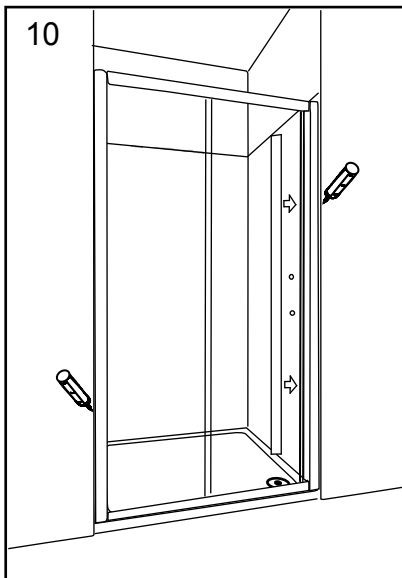

10 - Once you are happy that the installation is correct and that the door is running smoothly , push the cover caps onto the edges and tops of the wall channel as shown , ( smaller top cap first followed by the larger wall channel top cap and then the wall channels snap on cover) then silicone the outside of the enclosure where the metal profiles meet the wall and the tray.

To finally seal the installation, plug the small holes at the end of the fixed panel glass with a dab of silicone and insert the glass clips as illustrated.

Do not use the enclosure for 24 hours.

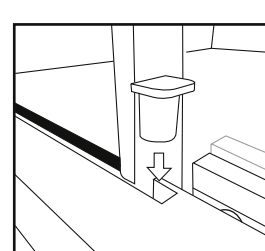
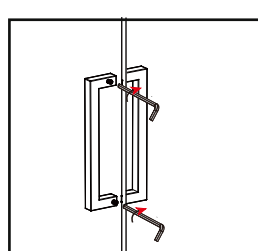
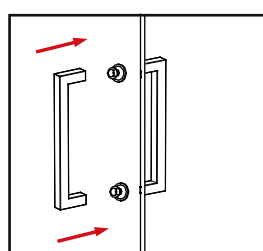
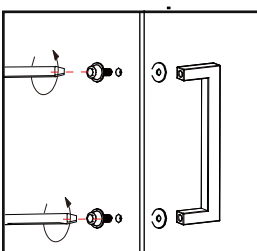



## AFTERCARE

### Cleaning Instructions

It is important to clean your Aquadart shower enclosure after every use. Please wipe down all glass and metal parts with a clean soft cloth. Ensure that all residual water on the glass is removed after every use.

### Usage

For reliable, watertight performance from your Aquadart enclosure your shower head should not be positioned so that the shower sprays directly onto the enclosure door. Failure to comply with this may cause the shower to leak. Outward opening doors may cause water to drip onto the floor, please ensure that the floor covering immediately outside the enclosure will not be affected by water.

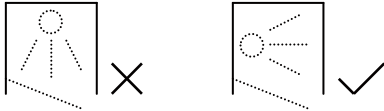

This product has been treated with Clean & Clear™ easy clean glass treatment, a protective barrier which creates a 'non-stick' surface on your glass, helping to resist lime scale build up and water spots. For further information on Clean & Clear™ please visit [www.aquadart.co.uk](http://www.aquadart.co.uk)

### Aftercare

Clean & Clear™ glass can be cleaned with any suitable nonabrasive glass cleaner - with PH value of between 3-11; the coating will not be damaged. Avoid surfactants and heavily perfumed products. Vinegar and water based products are very effective. Do not use abrasive scrubbing cleaners or equipment for cleaning.

### Warranty

Limited 5 year Warranty for Clean & Clear™ treatment: To guarantee treated surfaces will remain more repellent than untreated glass for 5 years from start of use, as long as basic manufacturer maintenance recommendations are followed and no harsh or abrasive cleaners are used.

AQUADART

Riverside Business Park, Royd Ings Avenue, Keighley, West Yorkshire, BD21 4AF  
For technical / aftersales queries, please visit our website : [www.aquadart.co.uk](http://www.aquadart.co.uk)  
or Sales Tel : 01535 613830 Technical: 01535 613830 Fax: 01535 613831

